

---

INSTRUCTION MANUAL  
**EVO TS<sup>V2</sup>**

---



# EVO TS<sup>V2</sup>

AIR TENT



## KEY TIPS



Before inflating your tent, start by pegging the corners and ensure the tent is fully pegged with the floor sitting flat. The floor seam should have tension between each peg loop.



Do not over tension guy ropes, the guy ropes should be taught but shouldn't pull your tent out of shape.



Ensure all doors are zipped closed before inflating and deflating. This helps the tent keep its shape and prevents undue stress on panels and zips.



Internal window panels can be half opened to control airflow and privacy. Fold window panels so they sit between the lower cover and mesh panel.



Ensure your air tubes are inflated to the correct pressure by using the pressure release valve and gauge on the pump.



When rolling up door panels, fold the outer corners into the centre and roll inwards. This prevents the edges hanging loose and prevents water from pooling in the roll.



Twist anchor webbing straps into a spiral before pegging to prevent them flapping in the wind.



On warm or humid nights, zip down the top of the 360° door cover. This provides maximum ventilation while maintaining your privacy.

- External Dimensions
- Internal Dimensions
- Entry/Exit
- Mesh Vent
- 3-Way Window
- Mesh Door
- Mesh Window
- Door/Window Cover
- Internal Floor Area
- Bedroom Area
- Awning Area
- Storm Skirt
- Powercord Access
- Lantern Hanging Point

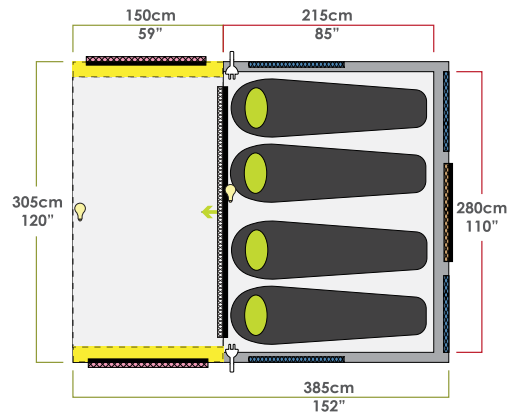

### EVO TM/TS<sup>V2</sup> AWNING WALL SET

Enjoy two different options to enclose the awning space of your Evo TM<sup>V2</sup> or Evo TS<sup>V2</sup> tent. Both a fully waterproof poly wall and bug-proof mesh wall are included.



### EVO TS<sup>V2</sup> ROOF COVER

Helps reduce internal temperature and keeps the inside of your tent darker. Also protects your roof from pollen, tree sap and other debris.

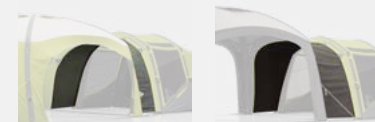

### EVO TS<sup>V2</sup> LINKS

Connect your Evo TS<sup>V2</sup> to an Aerobase or Roadiebase Air Shelter with a weatherproof link. Zips on easily to hugely extend your outdoor living space.



### EVO TS<sup>V2</sup> SOLID GROUND SHEET

Protects the tent floor and simplifies clean-up. Made from PE, it provides additional weather protection as it extends to cover the awning area.



OPTIONAL ADDONS

# PITCHING INSTRUCTIONS

## 1. Test Run

Practice pitching your tent at home to ensure you understand the process.

## 2. Pick A Site

When picking a site for your tent, try to find an area that is sheltered, flat and free from sharp objects. If possible, position your tent with the front door facing away from the prevailing wind. Try not to pitch your tent under trees as falling branches or sap can damage the tent.

## 3. Ground Sheet

To protect your tent from dirt and damage, it is recommended to use a Zempire® Ground Sheet. Ground Sheets not only protect your tent floor but also make pack down faster and cleaner. The Ground Sheet should be pegged down in the correct position first, then the tent placed on top. Zempire® Ground Sheets are slightly smaller than the size of the tent floor to ensure water does not collect between the two layers.

## 4. Unpacking

When you take your tent out for the first time, take a moment to see how it is packed or take a photo with your phone. This will help you when it comes to packing your tent away. Separate and identify the different parts included with your tent. The package should include the following:

- Tent
- Tent inner (pre-attached)
- Pump (built-in pressure gauge)
- Hose (with 2 nozzles)
- 32x Dome Pegs 6mm
- Guy Ropes (pre-attached)
- Repair kit (see peg bag)

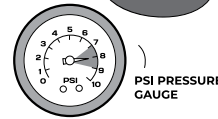
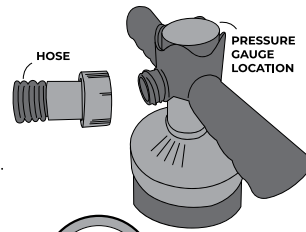

## 5. Pump Setup

Your Zempire® High Pressure Pump included with your tent comes with a pressure gauge to ensure that the air tubes are inflated to the correct level. The pump accessories should be assembled in the configuration shown.

## 6. Layout

Unroll the tent with the floor facing down. The large awning/entrance is located at the front of the tent. Peg out the 4 corners of the sewn-in ground sheet (●), ensuring there is significant tension between each point and that the floor sits as flat as possible. Peg the front corners of your awning so the awning walls are in-line with the body of the tent. Ideally the pegs should be angled away from your tent at 45°.

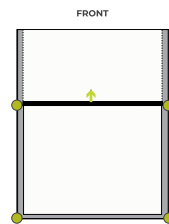

## 7. Airflow

Your tent will arrive with the bottom of the front door open to help increase airflow during the first pitch. It is important however that the doors remain predominantly closed during the pitching process to ensure the tent holds its correct shape during inflation and is not over tightened, which can cause damage. To enable air to enter during the pitching process, all window covers should be opened.

## 8. Boston Valve

The external inflation valves are located under the rain socks along the right side of the tent. Before inflating, remove the valve cap (A) and screw the boston valve (B) into the threaded section attached to the tubes. It is important that the valve is not cross threaded and is firmly tightened. Make sure no fabric is stuck in the valve as this will cause air to leak.

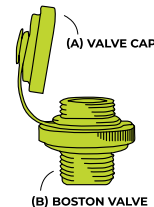

## 9. Inflation

Start with the second tube from the front and work your way to the rear tube. The last tube to be inflated is the front tube. Connect the pump via **NOZZLE A** to the boston valves and inflate to 7-9 PSI. It is important not to over-inflate the tubes.

It is recommended that during very hot weather, 7 PSI is used to provide room for expansion during the day. In cooler or windier conditions, 9 PSI is recommended. As each tube inflates, it may be necessary to support the centre of the tubes until they assume their correct shape.

## 10. Setting the Floor

It may be necessary to align the base of each air tube so that the floor sits flat and taught. You may also need to realign the corner pegging points so the floor sits flat.

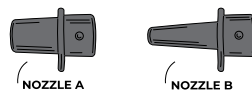

## 11. Pegging

Peg the remaining peg loops around the tent. Durable steel pegs are included with your tent which will be suitable for the majority of conditions. However, when camping at a rocky or sandy location, you may wish to purchase more specialised pegs. A range of specialised Zempire® Pegs may be available in your local region or on our website.

## 12. Anchor Webbing Straps

Anchor webbing straps are located at each end of your tent. These webbing straps are essential for the stability of your tent. They should be firmly pegged out at a 45° angle. In windy conditions or when camping on soggy ground you may need to double peg the steel "O" rings at the base of each strap. Anchor webbing straps should be used at all times.

## 13. Vents

To reduce condensation, it is important that the vents are opened at all times. Your tent is designed with a high/low ventilation system that relies on all vents being opened to achieve good air circulation. If you find condensation building up on the inside of your fly, it is recommended that the 360° front door cover is opened to allow maximum airflow. Zempire® tents have a large number of ventilation options, however in certain conditions condensation may occur. Condensation and its effects are not covered by warranty.

## 14. Guy Ropes

Guy ropes are pre-attached on all Zempire® tents. It is recommended that guy ropes are used at all times. It is important not to over-tighten the guy ropes, they should sit taught but should not distort the shape of the tent.

## 15. Bedroom Inner

Although the inner for the bedroom is pre-attached, it will be necessary to tension each of the corner webbing straps after the tent is pitched. These should be loosened before taking the tent down, but do not need to be removed.

## 16. Deflation

- Close all the mesh doors, leaving the covers open to allow air to escape from the tent.
- Loosen the inner rooms webbing straps.
- Unpeg all guy ropes and roll up to ensure they do not get tangled during packing.
- Unpeg the anchor webbing straps.
- Unpeg all peg points except the four corners.
- Clean and dry all pegs before storing in the bag.
- Unscrew the boston valves on each air tube. Wait for all the air to be expelled.
- Unpeg the four corners of the tent. Clean and pack the pegs.
- Lay the carry bag at one end of the tent. Fold the tent to 2/3s of the length of the bag. The tent should be folded parallel to the air tubes.
- Place the pump and peg bags on top of the folded tent at the end opposite the valves. Roll the tent from the "non-valve" side to the "valve-side" to help expel any remaining air from the tubes. It may take more than one roll to expel all the air from the tent.
- Use the webbing compression straps to secure the rolled tent and stand on its end.
- Pull the carry bag over the rolled tent. Flip the tent over and tension the carry bag drawcord and compression straps.
- The carry bag is over sized to ensure easy packing.

## Condensation

It is important that lower vents are opened at all times to reduce the risk of condensation. During humid or damp conditions, it is recommended that the window covers are opened to expose the mesh layer, enabling additional airflow throughout your tent.

Do not use foam swabs or non-bonded mats directly on the tent floor. This will cause condensation between the mat and floor and if not dried out, can lead to mildew forming.

## UV Degradation

Tent fabrics can be weakened by prolonged exposure to sunlight. Under normal holiday use, your Zempire® tent will give you many years of camping enjoyment. However, extended use in strong sunlight will cause degradation. It is recommended that during periods of strong sunlight a Zempire® Roof Cover is used to help protect from UV damage. UV degradation is not covered under warranty. The warranty does not cover permanent sites, displays or commercial use.

**For a detailed description of all the features and specifications please visit our website.**

## CARE INSTRUCTIONS

1. Ensure guy ropes are out at all times during use.
2. Make sure you have all vents open at all times. Constant airflow will drastically reduce condensation in humid weather conditions. Never cook in your tent as it is unsafe and would also heavily increase condensation.
3. Never pack your tent away wet. If you must take your tent down when wet, ensure that it is dried completely as soon as possible to prevent mildew forming.
4. If mildew does form on your tent, wash off with warm water and a soft brush to prevent further growth. Do not use soap or detergents.
5. Do not use aerosol spray cans or an open flame inside your tent. The fabric has been treated with a fire retardant but is in no way fire-proof.
6. Always use a peg puller to remove pegs. Never remove pegs by pulling the tent or peg loops; always clean and dry pegs before storing.
7. This tent is not designed to withstand storm conditions. During a severe storm, it is recommended that the tent be taken down.
8. Do not leave your tent pitched unnecessarily for extended periods of time. UV light damages the fly and will shorten the life of your tent.

## NEED HELP WITH YOUR TENT?

**We have a range of videos on our website which can help you.**

Follow the QR code or type the link below in your browser. We suggest to check out our videos beforehand in case you don't have service at your holiday destination.

TO THE  
VIDEO  
GALLERY



ZEMPIRECAMPING.INFO/VIDEO-GALLERY

## 3 Year Limited Warranty

**Please take time to read about the protection we offer you.**

All our products come with a guarantee designed to protect you as our valued customer. Zempire® Camping Equipment will repair or replace this product, at their discretion, should it fail due to faulty materials or manufacture for a period of 3 years from the date of purchase.

The Guarantee is subject to the following conditions:

1. The Guarantee only applies to an original purchaser who purchased this product in an unopened condition from an approved retail outlet.
2. The Guarantee does not apply if the product has been used for anything other than reasonable personal use. Commercial use (e.g. rental) or continuous use are expressly excluded.
3. Damage due to normal wear and tear, accident, acts of God, negligence (other than by Zempire® Camping Equipment), failure by the purchaser to ensure instructions for setting up and care are observed, deterioration due to abnormal exposure to ultraviolet light, damage from wind, insects, animals or mold/mildew, or any other cause reasonably beyond the control of Zempire® Camping Equipment are not covered.
4. If redress is sought under the terms of this Guarantee, then the product must be returned by the purchaser to the outlet from where it was purchased within the Guarantee period, in a clean, dry state and with proof of purchase.
5. All transport costs and any other indirect costs are excluded from the Guarantee.
6. Zempire® Camping Equipment reserves the right to make a reasonable charge for repairs which it determines are not within the scope of the Guarantee.
7. The Guarantee does not limit, modify or exclude any rights under any law if doing so would contravene that law or make any part of this Guarantee invalid. However, Zempire® Camping Equipment:
  - a) excludes (to the extent permitted by applicable law) all conditions and warranties that might otherwise be implied; and
  - b) limits its liability for breach of any such condition or Guarantee that it cannot exclude together with its liability under the Guarantee, to repairing or replacing the Goods or paying the cost of having the Goods repaired or replaced (at Zempire® Camping Equipment's option).

### Australia Only

Our goods come with guarantees that cannot be excluded under Australian Consumer Law. You are entitled to a replacement or refund for a major failure and compensation for any other reasonably foreseeable loss or damage. You are also entitled to have the goods repaired or replaced if the goods fail to be of acceptable quality and the failure does not amount to a major failure.

### USA Only

Some states do not allow the exclusion or limitation of incidental or consequential damages, so the above limitation or exclusion may not apply to you. This warranty gives you specific legal rights, and you may also have other rights which vary from state to state.

### Europe Only

The consumer has legal rights under applicable national legislation governing the sale of consumer goods and those rights are not affected by the guarantee.

All warranty claim processes are explained on our Zempire® website [/warranty](#) and follow the instructions to lodge a warranty claim.

### Sales Offices:

#### New Zealand & Australia

Zempire® Camping Equipment  
6 Karewa Place, Pukete,  
Hamilton, 3200, New Zealand  
Ph: +64 7 848 1610

#### USA & Canada

Zempire® USA INC.  
22525 SE 64th Place, Suite 200  
Issaquah, WA, 98027  
Ph: +1 206 420 0391

**Designed and tested in New Zealand. Made with care in China.**

## ⚠ WARNING

### KEEP ALL FLAME AND HEAT SOURCES AWAY FROM THIS TENT FABRIC

This tent meets the flammability requirements of CPAI-84. The fabric may burn if left in continuous contact with any flame source. The application of any foreign substance to the tent fabric may render the flame-resistant properties ineffective.

**zempire®**  
CAMPING EQUIPMENT



@zempirecamping #zempirefamily

## **i** INFO

Please read this instruction manual carefully and follow all instructions, guidelines, and safety warnings.

Included in this product instruction manual are warnings and precautions in relation to the safe use, care, assembly, maintenance, and storage of this product. By using the product, you confirm that you have read the product instruction manual and understand all warnings and precautions and agree that the product shall only be used for the intended purpose and application in accordance with the instructions, guidelines, and warnings in this product instruction manual as well as in accordance with all applicable laws and regulations. A failure to read, understand and follow the instructions and warnings may result in death or injury to yourself and others as well as damage to your product.

This manual, including the instructions, guidelines, and warnings, and related documentation, may be subject to changes and updates.

These instructions MUST be kept with this product for future reference.

### **WARNING & SAFETY REFERENCE EXPLANATIONS**

**⚠ DANGER!** – Safety instruction: Indicates a hazardous situation that, if not avoided, will result in death or serious injury.

**⚠ WARNING!** – Safety instruction: Indicates a hazardous situation that, if not avoided, could result in death or serious injury.

**⚠ CAUTION!** – Safety instruction: Indicates a hazardous situation that, if not avoided, could result in minor or moderate injury.

**ⓘ NOTICE!** – Indicates a situation that, if not avoided, can result in property damage.

**i NOTE!** – Supplementary information for using the product.

## **⚠ DANGER**

Failure to obey this instruction will cause death or serious injury.  
**HAZARD OF CARBON MONOXIDE POISONING**



Never use fuel-burning appliances such as barbecues, gas heaters or gas cookers inside the tent/shelter. The burning process produces carbon monoxide which accumulates inside the tent/shelter and can cause death.

## **⚠ WARNING**

Failure to obey these warnings could result in death or serious injury.  
**FIRE HAZARD**

Do not cook inside the tent/shelter or use open flames.

## **⚠ WARNING**

Failure to obey these warnings could result in death or serious injury.  
**BEWARE OF SUFFOCATION**

Make sure ventilation openings are always open to avoid suffocation.

## **⚠ CAUTION**

Failure to obey these cautions could result in minor or moderate injury.  
**INJURY RISK**

This product is not intended for use by persons (including children) with reduced physical, sensory, or mental capabilities, or lack of experience and suitable knowledge, unless they have been given supervision or instruction by a person responsible for their safety.

Guy lines are a trip hazard, do not allow children to play near the tent and ensure that suitable protective footwear is worn.

Maintenance or cleaning of this tent/shelter is not to be undertaken by unsupervised children.

## **⚠ DANGER**

Failure to obey this instruction will cause death or serious injury. **ELECTRIC SHOCK AND/OR ELECTROCUTION HAZARD**

- The use of the Power cord access points to run an extension cord into the tent/shelter may lead to electric shock, electrocution, fire or explosion hazards.
- **DO NOT** use any extension cord that is worn or damaged in anyway.
- **DO NOT** allow electrical devices, appliances, or extension cord to encounter condensation, water, or moisture inside the tent/shelter.
- Only use extension cords that are marked and certified for **OUTDOOR USE**.
- USA: Only connect extension cord to a 120 Volt GFCI (ground fault circuit interrupter) protected outlet with proper ground. If GFCI outlet is not available, use an extension cord with GFCI built in protection.
- AU/NZ: Only connect extension cord to a 240 Volt RCD (residual current device) protected outlet with proper ground. If RCD outlet is not available, use an extension cord with RCD built in protection.
- Ensure that the extension cord outside the tent/shelter is lower than the Power Cord entry into the tent so moisture will not travel along the cord and into the tent/shelter.
- Follow all instructions, warnings, and safety precautions from the manufacturer of the extension cord.
- Store tent/shelter and extension cord separately.

## **⚠ CAUTION**

**RISK OF INJURY AND MATERIAL DAMAGE**

- Never open the zip on the protective sleeve around an air pole while the pole is inflated. This will result in the air pole bursting.
- Only inflate the air poles to the recommended pressure using the supplied (or Zempire recommended) pump.

## **i** INTENDED USE

**This product is suitable for:**  
Light to moderate weather and family camping.

**This product is NOT suitable for:** Use above the snowline or in severe winds, commercial use, or long-term pitching.

This product is suitable only for the intended purpose and application in accordance with these instructions. This manual provides information that is necessary for proper and correct use of the product.

Improper use or maintenance will result in diminished performance and potential failure.

The manufacturer accepts no liability for any injury or damage to the product resulting from:

- Incorrect assembly or usage.
- Incorrect maintenance or use of spare parts other than original spare parts recommended and supplied by the manufacturer.
- Alteration to the product without express permission from the manufacturer.
- Use for purposes other than those described in this manual.

Zempire® reserves the right to change product appearance and product specifications.

## **i** NOTICE

### **MATERIAL DAMAGE**

- During setup **DO NOT** open or close the zippers by force.
- During packdown **DO NOT** use force when dismantling the tent/shelter. Otherwise, you might damage fabric and other components.

### **CLEANING & MAINTENANCE: FABRIC DAMAGE**

- **DO NOT** use sharp or hard objects or cleaning agents for cleaning.
- **DO NOT** use mineral-based, soaps, chemicals, or detergents for cleaning.
- Gently remove tree sap and bird droppings from the fabric as soon as possible to avoid permanent damage to the material.
- If necessary, clean the fabric with clean water and a soft bristled brush.

## **i** STORAGE

Fully set up the tent/shelter for cleaning. Choose a sunny day for cleaning to ensure the material will dry thoroughly.

Clean the tent/shelter thoroughly, including the inside to be sure no food etc is left inside to attract rodents etc.

Air the tent/shelter fully and ensure the tent is totally dry before packing away.

Store in a well-ventilated dry place inside the supplied carry bag.

## **i** DISPOSAL



Recycle all packaging material.

Do not discard into normal household garbage or landfill. Please contact local recycling facilities to recycle.