

Care Instructions

1. Ensure guy ropes are out at all times during use.
2. Never pack your tent away wet. If you must take your tent down when wet, ensure that it is dried completely as soon as possible to prevent mildew forming
3. If mildew does form on your tent, wash off with warm water and a soft brush to prevent further growth, do not use soap or detergents
4. Do not use an open flame inside your tent. The fabric has been treated with a fire retardant but is in no way fire proof
5. Clean all pegs and poles before storing
6. This tent is not designed to withstand storm conditions. During strong winds, it is recommended that the tent be taken down
7. Do not leave your tent pitched unnecessarily for extended periods of time, UV light damages the fly and will shorten the life of your tent

Condensation

It is important that lower vents are opened at all times to reduce the risk of condensation. During humid or damp conditions, it is recommended that inner door covers are opened to expose the mesh layer to allow additional airflow throughout your tent.

Do not use foam swabs or non bonded mats directly on the tent floor. This will cause condensation between the mat and floor and if not dried out can lead to mildew forming.

4 Year Tent Guarantee

Please take time to read about the protection we offer you

All our tents come with a guarantee designed to protect you as our valued customer. Flow Imports Ltd, the makers of Zempire Camping Equipment tents, will repair or replace this tent, at their discretion, should it fail due to faulty materials or manufacture for a period of 4 years from the date of sale.

The Guarantee is subject to the following conditions:

1. The Guarantee only applies to an original purchaser who purchased this tent from an approved retail outlet
2. The Guarantee does not apply if the tent has been used for anything other than reasonable personal camping use. Commercial use (e.g. rental) or continuous use as a residence are expressly excluded
3. Damage due to normal wear and tear, accident, acts of God, negligence (other than by Flow Imports Ltd), failure by the purchaser to ensure instructions for setting up and care are observed, deterioration due to abnormal exposure to ultraviolet light, insect or mildew attack, or any other cause reasonably beyond the control of Flow Imports Ltd are not covered
4. If redress is sought under the terms of this Guarantee, then the tent must be returned by the purchaser to the outlet from where it was purchased within the Guarantee period, in a clean, dry state and with proof of purchase
5. All transport costs and any other indirect costs are excluded from the Guarantee.
6. Flow Imports Ltd reserves the right to make a reasonable charge for repairs which it determines are not within the scope of the Guarantee
7. The Guarantee does not limit, modify or exclude any rights under any law if doing so would contravene that law or make any part of this Guarantee invalid. However, Flow Imports Ltd:
a) excludes (to the extent permitted by applicable law) all conditions and warranties that might otherwise be implied; and
b) limits its liability for breach of any such condition or Guarantee that it cannot exclude together with its liability under the Guarantee, to repairing or replacing the Goods or paying the cost of having the Goods repaired or replaced (at Flow Imports' option).

This tent has been made with meticulous care and attention to detail. Providing it's properly looked after and correctly stored, it will help you enjoy all that nature has to offer for years to come.

Get out more - you owe it to yourself.

For a detailed description of all the features and specifications of this product please visit our website.

WWW.ZEMPIRECAMPING.COM

Tested in New Zealand. Made with care in China

Zempire
CAMPING EQUIPMENT

AERO™ PRO TC
zempire CAMPING EQUIPMENT PRO TC SERIES



1 Peg out the 4 corners of the tent.

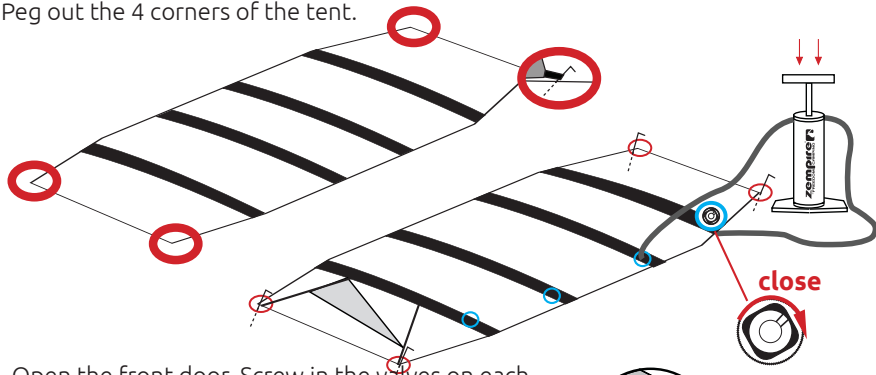

2 Open the front door. Screw in the valves on each pole line. Inflate from front of tent to rear. Two poles can be inflated at the same time. It may help to have someone support the poles while inflating. Once inflated, close the valve cap ensuring not to cross thread.

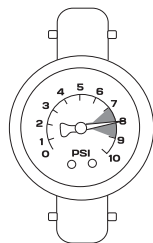
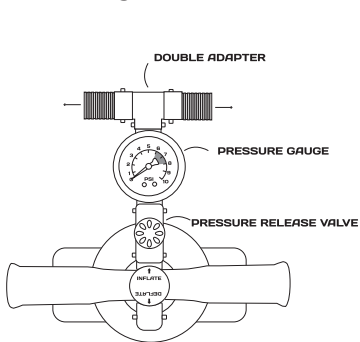

Pump attachments should be configured as shown. The pressure release valve will engage once 9 PSI is achieved.

DO NOT INFLATE ABOVE 9PSI.

3 Peg out all peg points and anchor supports. Close the front door to ensure correct alignment. It is recommended that guy lines are pegged out at all times.

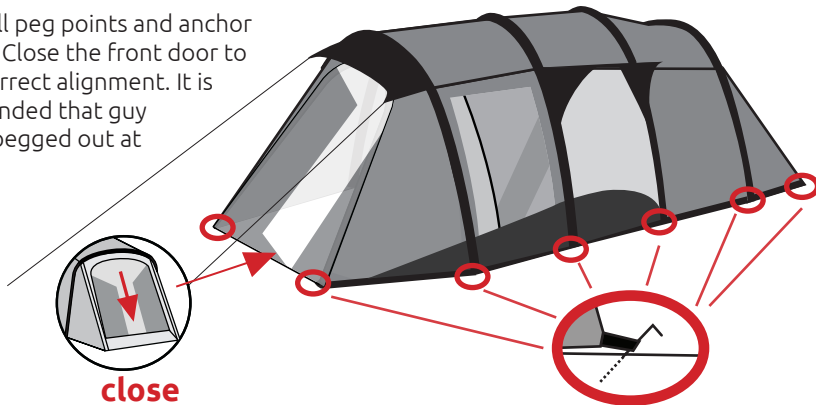

TAKING DOWN

1 Open the front door. Remove the valves working from rear of tent to front.

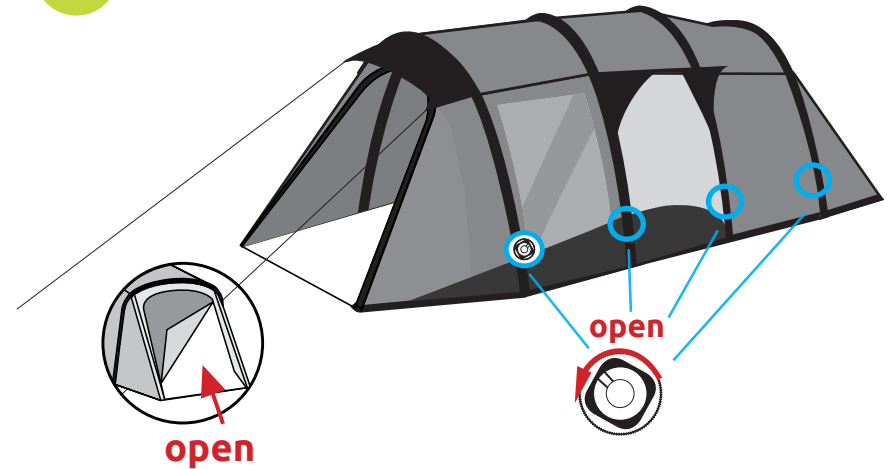

2 Fold the tent towards the valve ends to expel the air.

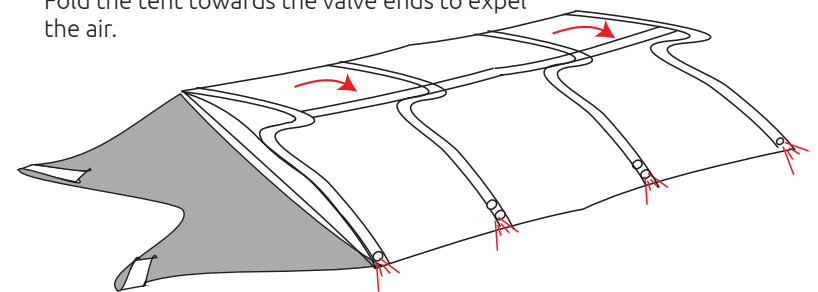

3

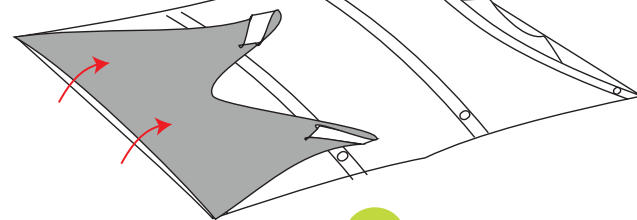

4

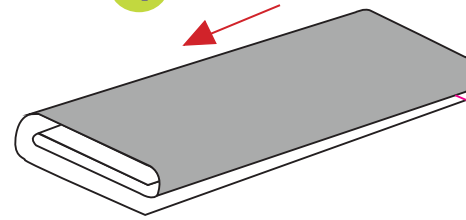

5

